

 **KLEWE**
SISTEMASOLARE

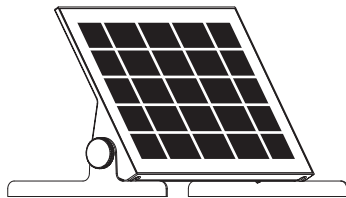

ELEKTRON



MADE IN CHINA

DESIGNED IN ITALY BY FRANCO PAGLIARINI
WWW.KLEWESOLAR.EU

VERSION 1.0 

1.

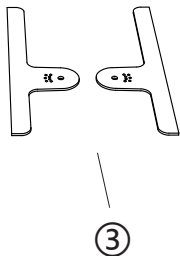
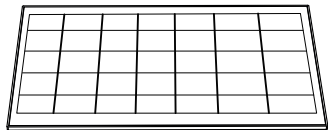
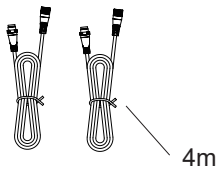
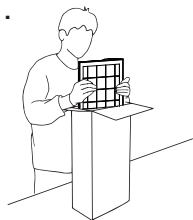

2.

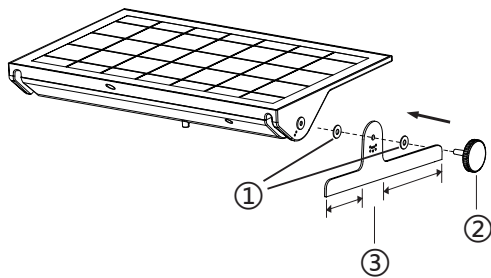

3.

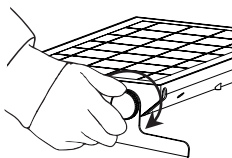

4.

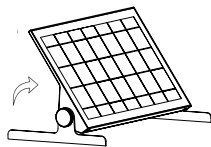

8.

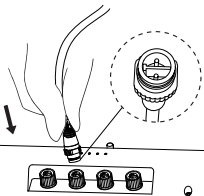

9.

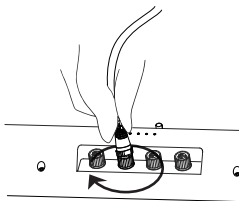

10.

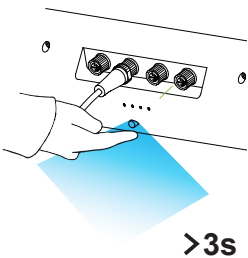

11.

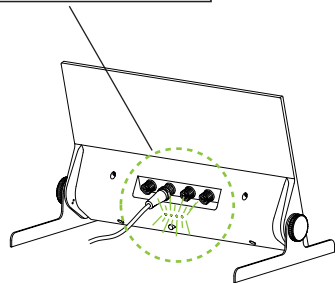
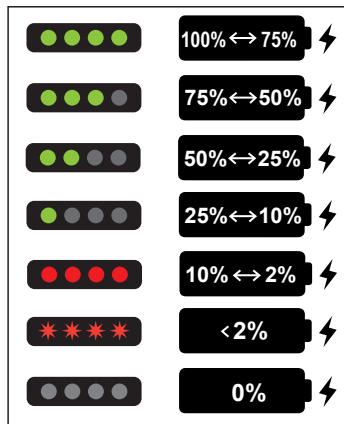
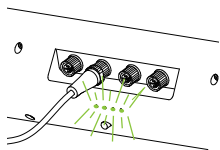

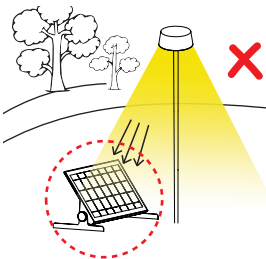
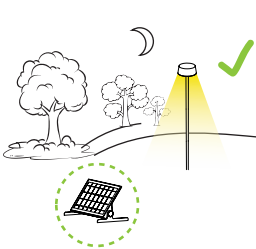
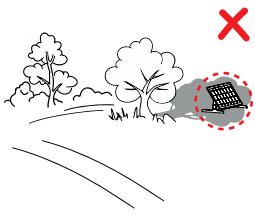
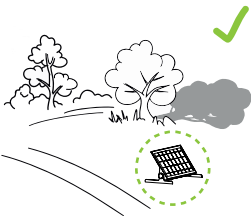
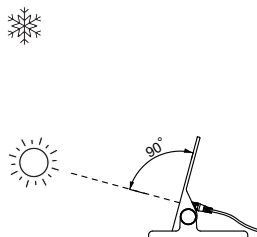
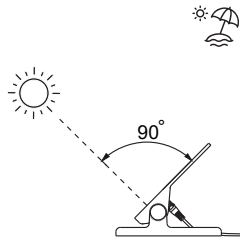

1h	30%
2-4h	100%
5h----	20%
* ≤25%	20%

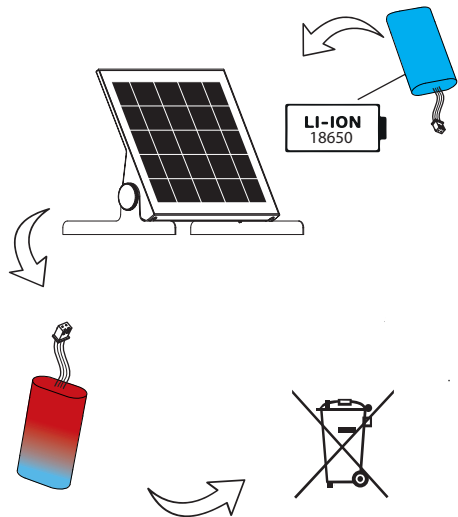
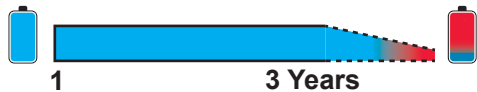

1.

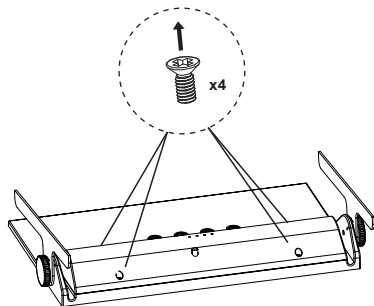

2.

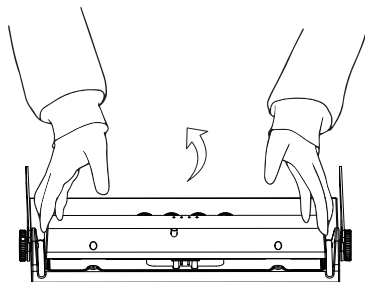

3.

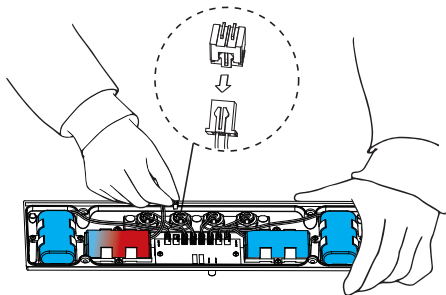

◆▲▲	IP65
⚡	8-10h
💡	26-28h
LI-ION	4*4400mAh
☀️	16W

4.

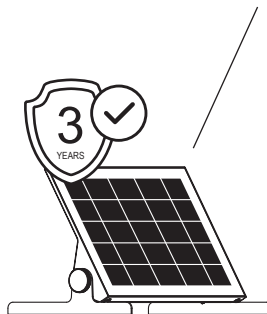
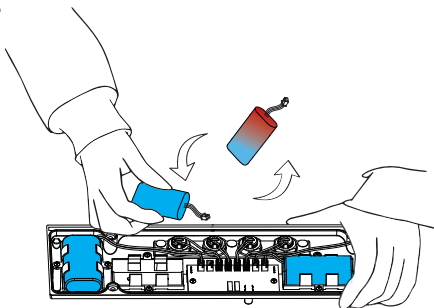



 **Europe:**



www.klewsolar.eu

 **Asia pacific:**



www.klewsolar.com



info@eddsrl.eu



info@klewsolar.com